

# CONTRACT FURNITURE

221 to 234



# Knürr Cabinets

Premium in every Detail



Hard-wearing and easy to clean surface



Reliable espagnolette lock



ABS edge veneers all around



Segment bow handle



Metal levelling feet adjustable from cabinet inside for easy levelling

Smooth-running sliding doors



Rugged soft-close hinges with limiter (110°)



Turning handle suitable for locking system

## INDIVIDUALLY CONFIGURABLE LOCKING SYSTEM

- General Master Key (GMK) for all locking categories.
- Changeable cylinder system.
- Allows future customization.

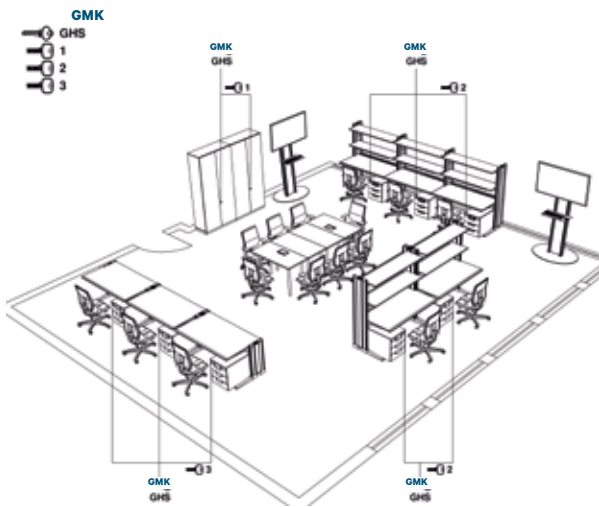

	GMK12 1.800.200	Turns locks of groups A and B.
	07001 - 00000 1.800.370	<b>General Master Key</b> Turns locks of group A or B
	HEA12 07001 - 07500	<b>Master key</b>
	HSB12 04 017 131 D 07501 - 00000	Lock removal when lock opened. Turns locks of groups A and B.
	MA800 07001 - 00000	<b>Removal key</b>
	07001 - 07500 04 528 000.1 + 5x16	Reversible key. Profiled flat key. Turns one lock.
	07501 - 00000 04 528 000.3 + 5x16	<b>Key B5</b>
	07001 - 07500 04 528 000.1 + 5x16	Reversible key. Turns one lock.
	07501 - 00000 04 528 000.1 + 5x16	<b>Key B1</b>

- The contoured key profile ensures a high technical copy protection, owing to a testing unit both at lock and cylinder.
- Combines within the locking system.

- Sophisticated system with attractive value-for-money.
- Highest product quality and reliability for long-term use.

## Finishes:



Design .1 light grey  
(On request .7 ESD light grey)

Design .5 beech Individual finishes optional (on request)



\*Electrostatic discharge

# Knürr Cabinets

Order system – Double door cabinets

**Wall-standing cabinet with double doors / Glass door cabinet**  
2 FH / 3 FH / 5 FH

- Completely bonded and doweled corpus made of melamin resin coated chipboards according to EN 14332
- All-around, pre-assembled pedestal with metal levelling feet to compensate surface irregularities
- Slotted, bonded back panel, 13 mm thick, as decorative rear
- Doors with metal strap hinge with softclose-automatic, opening angle 110°
- Espagnolette lock with cremone bolt and alternating cylinder (compatible with locking systems )
- Edges 2 mm ABS, rounded
- Metal shelf (see order chart) RAL 9011 black, adjustable in 32 mm grid, load capacity 75 kg/qm for all compartments
- With glass double doors:  
Optional partial glass door: chipboard door with 4mm safety glass infill

- **Colour**  
**Final digit of order number .1:**
  - Fully light grey**Final digit of order number .5:**
  - Body RAL 7021 black grey
  - Beech décor front
- **Supply schedule**
  - 1 wall standing cabinet with hinged door**With glass door:**
  - 1 wall standing cabinet with partially glassed door
- **How supplied**
  - Assembled
- **Please note**
  - The doors with the knob are always right hinged (RA) in standard. Left hinged doors (LA) on request.

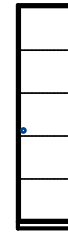

500 x 2064 mm  
(Picture: 5 OH)

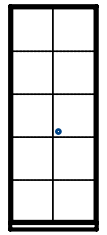

800 x 2064 mm  
(Picture: 5 OH)

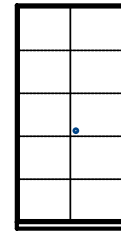

1000 x 2064 mm  
(Picture: 5 OH)

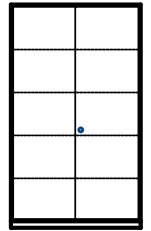

1200 x 2064 mm  
(Picture: 5 OH)

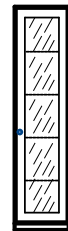

500 x 2064 mm  
(Picture: 5 OH)



800 x 2064 mm  
(Picture: 5 OH)

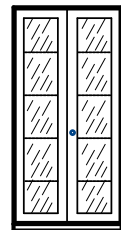

1000 x 2064 mm  
(Picture: 5 OH)

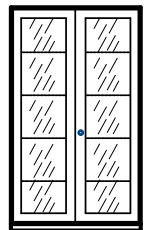

1200 x 2064 mm  
(Picture: 5 OH)

W	H	No. of shelves	FH	Type	Order no. (D 430)	Order no. (D 650)	UP
500	772	1	2	door	00.321.400.x	00.321.600.x	1 unit
800	772	1	2	double door	00.321.401.x	00.321.601.x	1 unit
1000	772	1	2	double door	00.321.402.x	00.321.602.x	1 unit
1200	772	1	2	double door	00.321.403.x	00.321.603.x	1 unit
500	1352	2	3	door	00.321.404.x	00.321.604.x	1 unit
800	1352	2	3	double door	00.321.405.x	00.321.605.x	1 unit
1000	1352	2	3	double door	00.321.406.x	00.321.606.x	1 unit
1200	1352	2	3	double door	00.321.407.x	00.321.607.x	1 unit
500	2064	4	5	door	00.321.408.x	00.321.608.x	1 unit
800	2064	4	5	double door	00.321.409.x	00.321.609.x	1 unit
1000	2064	4	5	double door	00.321.410.x	00.321.610.x	1 unit
1200	2064	4	5	double door	00.321.411.x	00.321.611.x	1 unit
500	772	1	2	glass door	00.321.420.x	00.321.620.x	1 unit
800	772	1	2	glass double door	00.321.421.x	00.321.621.x	1 unit
1000	772	1	2	glass double door	00.321.422.x	00.321.622.x	1 unit
1200	772	1	2	glass double door	00.321.423.x	00.321.623.x	1 unit
500	1352	2	3	glass door	00.321.424.x	00.321.624.x	1 unit
800	1352	2	3	glass double door	00.321.425.x	00.321.625.x	1 unit
1000	1352	2	3	glass double door	00.321.426.x	00.321.626.x	1 unit
1200	1352	2	3	glass double door	00.321.427.x	00.321.627.x	1 unit
500	2064	4	5	glass door	00.321.428.x	00.321.628.x	1 unit
800	2064	4	5	glass double door	00.321.429.x	00.321.629.x	1 unit
1000	2064	4	5	glass double door	00.321.430.x	00.321.630.x	1 unit
1200	2064	4	5	glass double door	00.321.431.x	00.321.631.x	1 unit

**Dimensions:**

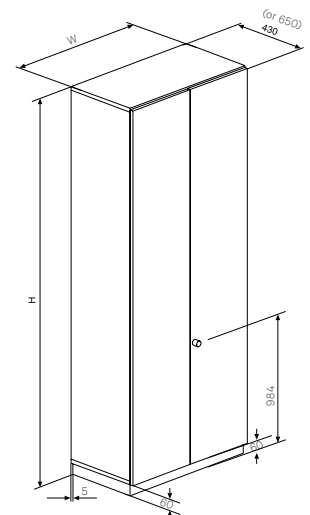

## Stackable cabinet with double doors

2 FH / 3 FH

- Completely bonded and doweled corpus made of melamin resin coated chipboards according to EN 14332
  - Slotted, bonded back panel, 13 mm thick, as decorative rear
  - Doors with metal strap hinge with softclose-automatic, opening angle 110°
  - Espagnolette lock with cremone bolt and alternating cylinder (compatible with locking systems )
  - Edges 2mm ABS, rounded
  - Metal shelf (see order chart) RAL 9011 black, adjustable in 32 mm grid, load capacity 75 kg/qm for all compartments
  - With glass double doors:  
Optional partial glass door: chipboard door with 4mm safety glass infi
- **Colour**  
**Final digit of order number .1:**
    - Fully light grey**Final digit of order number .5:**
    - Body RAL 7021 black grey
    - Beech décor front
  - **Supply schedule**
    - 1 stackable cabinet with hinged door
    - 1 wall standing cabinet with partially glassed doors
  - **How supplied**
    - Assembled
  - **Please note**
    - The doors with the knob are always right hinged (RA) in standard. Left hinged doors (LA) on request.
    - Please also ask for further accessories such as clothes rails.

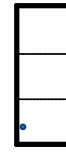

500 x 1292 mm

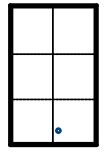

800 x 1292 mm

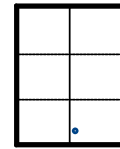

1000 x 1292 mm

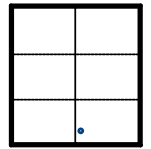

1200 x 1292 mm

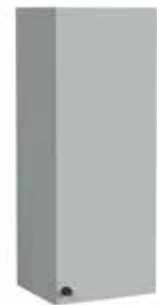

W	H	No. of shelves	FH	Type	Order no. (D 430)	Order no. (D 650)	UP
500	712	1	2	door	00.321.412.x	00.321.612.x	1 unit
800	712	1	2	double door	00.321.413.x	00.321.613.x	1 unit
1000	712	1	2	double door	00.321.414.x	00.321.614.x	1 unit
1200	712	1	2	double door	00.321.415.x	00.321.615.x	1 unit
500	1292	2	3	door	00.321.416.x	00.321.616.x	1 unit
800	1292	2	3	double door	00.321.417.x	00.321.617.x	1 unit
1000	1292	2	3	double door	00.321.418.x	00.321.618.x	1 unit
1200	1292	2	3	double door	00.321.419.x	00.321.619.x	1 unit
500	712	1	2	glass door	00.321.432.x	00.321.632.x	1 unit
800	712	1	2	glass double door	00.321.433.x	00.321.633.x	1 unit
1000	712	1	2	glass double door	00.321.434.x	00.321.634.x	1 unit
1200	712	1	2	glass double door	00.321.435.x	00.321.635.x	1 unit
500	1292	2	3	glass door	00.321.436.x	00.321.636.x	1 unit
800	1292	2	3	glass double door	00.321.437.x	00.321.637.x	1 unit
1000	1292	2	3	glass double door	00.321.438.x	00.321.638.x	1 unit
1200	1292	2	3	glass double door	00.321.439.x	00.321.639.x	1 unit

**Dimensions in mm:** W= Width  
 H = Height  
 D = Depth  
 OU = Office unit (50 mm)  
 FH = Folder height, min. 325 mm / 12,8"

Replace „x“ with the number of your color choice

LH = Left hinged  
 RH = Right hinged

Dw = Drawers  
 DU = Drawer unit

1 DU = 32 mm = 1¼"

## Wall-standing shelf unit

2 FH / 3 FH / 5 FH

- Completely bonded and doweled corpus made of melamin resin coated chipboards according to EN 14332
- All-around, pre-assembled pedestal with metal levelling feet to compensate surface irregularities
- Slotted, bonded back panel, 13 mm thick, as decorative rear
- Edges 2mm ABS, rounded
- Metal shelf (see order chart) 9011 black, adjustable in 32 mm grid, load capacity 75 kg/qm for all compartments

- **Colour**  
**Final digit of order number .1:**
  - Fully light grey**Final digit of order number .5:**
  - Body RAL 7021 black grey
- **Supply schedule**
  - 1 wall standing shelf unit
- **How supplied**
  - Assembled

W	H	No. of shelves	FH	Order no. (D 430)	Order no. (D 650)	UP
500	772	1	2	00.321.440.x	00.321.640.x	1 unit
800	772	1	2	00.321.441.x	00.321.641.x	1 unit
1000	772	1	2	00.321.442.x	00.321.642.x	1 unit
1200	772	1	2	00.321.443.x	00.321.643.x	1 unit
500	1352	2	3	00.321.444.x	00.321.644.x	1 unit
800	1352	2	3	00.321.445.x	00.321.645.x	1 unit
1000	1352	2	3	00.321.446.x	00.321.646.x	1 unit
1200	1352	2	3	00.321.447.x	00.321.647.x	1 unit
500	2064	4	5	00.321.448.x	00.321.648.x	1 unit
800	2064	4	5	00.321.449.x	00.321.649.x	1 unit
1000	2064	4	5	00.321.450.x	00.321.650.x	1 unit
1200	2064	4	5	00.321.451.x	00.321.651.x	1 unit

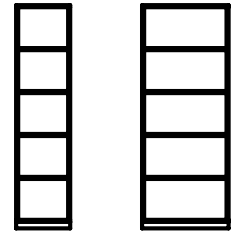

500 x 2064 mm

800 x 2064 mm

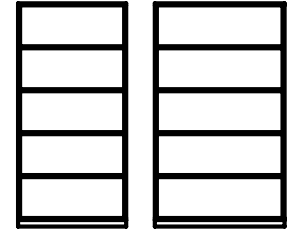

1000 x 2064 mm

1200 x 2064 mm



## Stackable shelf unit

2 FH / 3 FH

- Completely bonded and doweled corpus made of melamin resin coated chipboards according to EN 14332
- Slotted, bonded back panel, 13 mm thick, as decorative rear
- Edges 2mm ABS, rounded
- Metal shelf (see order chart) RAL 9011 black, adjustable in 32 mm grid, load capacity 75 kg/qm for all compartments

- **Colour**  
**Final digit of order number .1:**
  - Fully light grey**Final digit of order number .5:**
  - Body RAL 7021 black grey
- **Supply schedule**
  - 1 stackable shelf unit
- **How supplied**
  - Assembled

W	H	No. of shelves	FH	Order no. (D 430)	Order no. (D 650)	UP
500	712	1	2	00.321.452.x	00.321.652.x	1 unit
800	712	1	2	00.321.453.x	00.321.653.x	1 unit
1000	712	1	2	00.321.454.x	00.321.654.x	1 unit
1200	712	1	2	00.321.455.x	00.321.655.x	1 unit
500	1292	2	3	00.321.456.x	00.321.656.x	1 unit
800	1292	2	3	00.321.457.x	00.321.657.x	1 unit
1000	1292	2	3	00.321.458.x	00.321.658.x	1 unit
1200	1292	2	3	00.321.459.x	00.321.659.x	1 unit

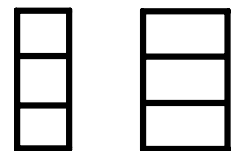

500 x 1292 mm

800 x 1292 mm

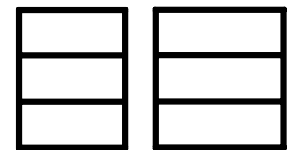

1000 x 1292 mm

1200 x 1292 mm



**Dimensions in mm:** W = Width  
H = Height  
D = Depth  
OU = Office unit (50 mm)  
FH = Folder height, min. 325 mm / 12.8"  
Replace „x“ with the number of your color choice

LH = Left hinged  
RH = Right hinged

Dw = Drawers  
DU = Drawer unit

1 DU = 32 mm = 1 1/4"

## Printer Cabinet

- Printer cabinet  
Width 1200 mm  
Depth 650 mm  
Height 750 mm
- With cable routing set D80mm at the rear side of top cover and at the bottom of side board
- Shortened shelves for cabling through cabinet
- 28mm top board with straight ABS edge on all sides
- **Material / finish**
  - Wooden main unit bonded, three layer particle board, FP/Y E1 version, directly coated, fire protection class B2  
Body, handles: light grey
- Can be adjusted with 4 levelling screws, with plinth
- All cabinets can be locked with cylinder lock
- With a centre panel
- Segment bow handle, matt nickel plated
- **Colour**
  - Main unit and shelf: RAL 7035 light grey
  - Top board: RAL 7035 lightgrey with black edge
- **Supply schedule**
  - 1 Printer cabinet
- **How supplied**
  - Pre assembled



W	H	D	Model	Order-no.	UP
1200	750	650		00.320.072.1	1 unit

## Printer Rack ECO

- Bonded wooden main unit
- Can be adjusted with 4 levelling screws at the bottom board
- With cable routing grommet through top board and bottom for raised floor cabling
- 28mm top board with straight ABS edge on all sides
- **Colour**
  - Main unit and shelf: RAL 7035 light grey
  - Top board: RAL 7035 lightgrey with black edge
- **Supply schedule**
  - 1 Printer cabinet



W	H	D	Order-no.	UP
600	750	630	00.320.210.1	1 unit
1200	750	630	00.320.211.1	1 unit

## High Desk, Octagonal

- High desk: perfect for discussions with several people on-site
- Octagonal with storage options for folders and equipment
- Bonded main unit
- **Material / Finish**
  - Worktop, main unit and shelves - three-layer particle board, FP/Y E1 version, directly coated, fire protection class B2
- **Standards**
  - EN 438 class for coating material
- **Color**
  - Worktop, main unit and shelves: light-grey
- **Supply schedule**
  - 1 standing console
- **How supplied**
  - Assembled
- **Note**
  - ESD model on request



W	H	D	Order no.	UP
1295	1150	1295	01.315.722.1	1 unit

CIC20035

## Cabinet with sliding doors

2 FH / 3 FH

- Completely bonded and doweled corpus made of melamin resin coated chipboards according to EN 14332
- Cabinet with middle support wall panel
- All-around, pre-assembled pedestal with metal levelling feet to compensate surface irregularities
- Slotted, bonded back panel, 13 mm thick, as decorative rear
- Doors with smooth-running roller gears, push-cylinder lock with exchangeable cylinder (compatible with locking systems), segment bow metal handle 160 mm
- Edges 2 mm ABS, rounded
- Metal shelf (see order chart), RAL 9011black, adjustable in 32 mm grid, load capacity 75 kg/qm for all compartments

- **Colour**
  - Final digit of order number .1:**
    - Fully light grey
  - Final digit of order number .5:**
    - Body RAL 7021 black grey
    - Beech décor front
    - Segment bow handle, matt nickel plated
- **Supply schedule**
  - 1 wall standing cabinet with sliding door
- **How supplied**
  - Assembled

W	H	No. of shelves	FH	Order no. (D 430)	Order no. (D 650)	UP
1200	772	1	2	00.321.460.x	00.321.660.x	1 unit
1200	1352	2	3	00.321.461.x	00.321.661.x	1 unit

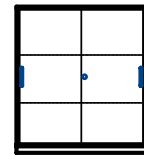

1200 x 1352 mm

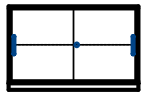

1200 x 772 mm



## Stackable cabinet with sliding doors

2 FH / 3 FH

- Completely bonded and doweled corpus made of melamin resin coated chipboards according to EN 14332
- Cabinet with middle support wall panel
- Slotted, bonded back panel, 13 mm thick, as decorative rear
- Doors with smooth-running roller gears, push-cylinder lock with exchangeable cylinder (compatible with locking systems), segment bow metal handle 160mm
- Edges 2 mm ABS, rounded
- Metal shelf (see order chart), RAL 9011black, adjustable in 32 mm grid, load capacity 75 kg/qm for all compartments

- **Colour**
  - Final digit of order number .1:**
    - Fully light grey
  - Final digit of order number .5:**
    - Body RAL 7021 black grey
    - Beech décor front
    - Segment bow handle, matt nickel plated
- **Supply schedule**
  - 1 stackable cabinet with sliding door
- **How supplied**
  - Assembled

W	H	No. of shelves	FH	Order no. (D 430)	Order no. (D 650)	UP
1200	712	1	2	00.321.462.x	00.321.662.x	1 unit
1200	1292	2	3	00.321.463.x	00.321.663.x	1 unit

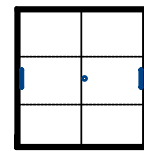

1200 x 1292 mm

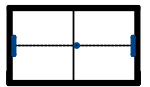

1200 x 712 mm





## Cabinet with tambour doors

2 FH / 3 FH

- Completely bonded and doweled corpus made of melamin resin coated chipboards according to EN 14332
- All-around, pre-assembled pedestal with metal levelling feet to compensate surface irregularities
- Slotted, bonded back panel, 13 mm thick, as decorative rear
- Shutter rollers made from smooth-running plastic lamellas, right to left, push-cylinder lock with exchangeable cylinder (compatible with locking systems), segment bow metal handle 160 mm
- Edges 2mm ABS, rounded
- Metal shelf (see order chart), RAL 9011black, adjustable in 32 mm grid, load capacity 75 kg/qm
- Conductive version not available

- **Colour**  
**Final digit of order number .1:**
  - Fully light grey**Final digit of order number .5:**
  - Body RAL 7021 black grey
  - Silver roller shutter
  - Segment bow handle, matt nickel plated
- **Supply schedule**
  - 1 cabinet with tambour doors
- **How supplied**
  - Assembled

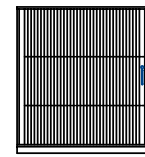

1200 x 1352 mm

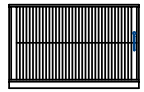

1200 x 772 mm



W	H	No. of shelves	FH	Order no. (D 430)	Order no. (D 650)	UP
1200	772	1	2	00.321.470.x	00.321.670.x	1 unit
1200	1352	2	3	00.321.471.x	00.321.671.x	1 unit

## Stackable cabinet with tambour doors

2 FH / 3 FH

- Completely bonded and doweled corpus made of melamin resin coated chipboards according to EN 14332
- Slotted, bonded back panel, 13 mm thick, as decorative rear
- Shutter rollers made from smooth-running plastic lamellas, right to left, push-cylinder lock with exchangeable cylinder (compatible with locking systems), segment bow metal handle 160mm
- Edges 2mm ABS, rounded
- Metal shelf (see order chart), RAL 9011black, adjustable in 32 mm grid, load capacity 75 kg/qm
- Conductive version not available

- **Colour**  
**Final digit of order number .1:**
  - Fully light grey**Final digit of order number .5:**
  - Body RAL 7021 black grey
  - Silver roller shutter
  - Segment bow handle, matt nickel plated
- **Supply schedule**
  - 1 cabinet with tambour doors
- **How supplied**
  - Assembled

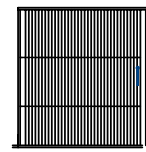

1200 x 1292 mm

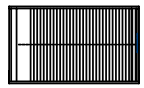

1200 x 712 mm



W	H	D	No. of shelves	FH	Order no. (D 430)	Order no. (D 650)	UP
1200	712	430	1	2	00.321.472.x	00.321.672.x	1 unit
1200	1292	430	2	3	00.321.473.x	00.321.673.x	1 unit

**Dimensions in mm:** W = Width  
 H = Height  
 D = Depth  
 OU = Office unit (50 mm)  
 FH = Folder height, min. 325 mm / 12,8"  
 Replace „x“ with the number of your color choice

LH = Left hinged  
 RH = Right hinged

Dw = Drawers  
 DU = Drawer unit

1 DU = 32 mm = 1¼"

## Wall-standing cabinet with drawers

### 2-3-4-5-7-9 drawers

- Completely bonded and doweled corpus made of melamin resin coated chipboards according to EN 14332
- All-around, pre-assembled pedestal with metal levelling feet to compensate surface irregularities
- Slotted, bonded back panel, 13 mm thick, as decorative rear
- Edges 2 mm ABS, rounded
- Drawer cabinet version (1 SE = 32mm)
- Slides:
  - Soft Close full pull telescopic slides
  - Load rating 650 N
- Drawer inside dimensions: 326 mm deep
- Drawer usable width = width of the cabinet: minus 110 mm
- Drawers made from powder-coated sheet steel, height 91 mm, black on telescopic full pull-out slides
- Trims with segment bow metal handle
- Numerous customer-specific variants of variable trim heights
- Top trim with cylinder lock with exchangeable cylinder
- Reciprocal pull-out locking mechanism tilt protection due to integrated counterweight

- **Colour**
  - **Final digit of order number .1:**
    - Fully light grey
  - **Final digit of order number .5:**
    - Body RAL 7021 black grey
    - Beech décor front
    - Segment bow handle, matt nickel plated
- **Supply schedule**
  - 1 wall-standing cabinet with drawers
- **How supplied**
  - Assembled

W	H	Dw	Dw Drawers (1 DU = 32 mm)	Order no.(D 430)	Order no.(D 650)	UP
800	772	2	11DU Top drawer / 1 x 11DU	00.321.474.x	00.321.674.x	1 unit
800	772	3	7 DU Top drawer / 1 x 7 DU / 1 x 8 DU	00.321.475.x	00.321.675.x	1 unit
800	772	4	7 DU Top drawer / 2 x 4 DU / 1 x 7 DU	00.321.476.x	00.321.676.x	1 unit
800	772	4	7 DU Top drawer / 3 x 5 DU	00.321.477.x	00.321.677.x	1 unit
800	1352	4	7 DU Top drawer / 3 x 11 DU	00.321.478.x	00.321.678.x	1 unit
800	1352	5	7 DU Top drawer / 3 x 8 DU / 1 x 9 DU	00.321.479.x	00.321.679.x	1 unit
800	1352	7	7 DU Top drawer / 3 x 4 DU / 2 x 6 DU / 1 x 9 DU	00.321.480.x	00.321.680.x	1 unit
800	1352	9	7 DU Top drawer / 7 x 4 DU / 1 x 5 DU	00.321.481.x	00.321.681.x	1 unit
1000	772	2	11 DU Top drawer / 1 x 11 DU	00.321.482.x	00.321.682.x	1 unit
1000	772	3	7 DU Top drawer / 1 x 7 DU / 1 x 8 DU	00.321.483.x	00.321.683.x	1 unit
1000	772	4	7 SDU Top drawer / 2 x 4 DU / 1 x 7 DU	00.321.484.x	00.321.684.x	1 unit
1000	772	4	7 DU Top drawer / 3 x 5 DU	00.321.485.x	00.321.685.x	1 unit
1000	1352	4	7 DU Top drawer / 3 x 11 DU	00.321.486.x	00.321.686.x	1 unit
1000	1352	5	7 DU Top drawer / 3 x 8 DU / 1 x 9 DU	00.321.487.x	00.321.687.x	1 unit
1000	1352	7	7 DU Top drawer / 3 x 4 DU / 2 x 6 DU / 1 x 9 DU	00.321.488.x	00.321.688.x	1 unit
1000	1352	9	7 DU Top drawer / 7 x 4 DU / 1 x 5 DU	00.321.489.x	00.321.689.x	1 unit
1200	772	2	11 DU Top drawer / 1 x 11 DU	00.321.490.x	00.321.690.x	1 unit
1200	772	3	7 DU Top drawer / 1 x 7 DU / 1 x 8 DU	00.321.491.x	00.321.691.x	1 unit
1200	772	4	7 DU Top drawer / 2 x 4 DU / 1 x 7 DU	00.321.492.x	00.321.692.x	1 unit
1200	772	4	7 DU Top drawer / 3 x 5 DU	00.321.493.x	00.321.693.x	1 unit
1200	1352	4	7 DU Top drawer / 3 x 11 DU	00.321.494.x	00.321.694.x	1 unit
1200	1352	5	7 DU Top drawer / 3 x 8 DU / 1 x 9 DU	00.321.495.x	00.321.695.x	1 unit
1200	1352	7	7 DU Top drawer / 3 x 4 DU / 2 x 6 DU / 1 x 9 DU	00.321.496.x	00.321.696.x	1 unit
1200	1352	9	7 DU Top drawer / 7 x 4 DU / 1 x 5 DU	00.321.497.x	00.321.697.x	1 unit

### 22 SE

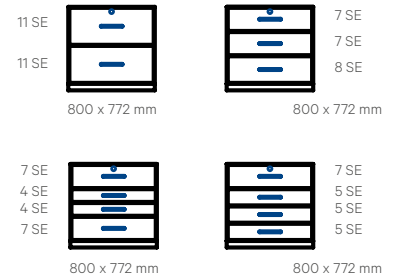

### 40 SE

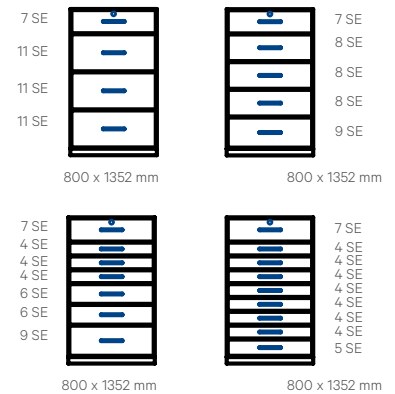

## Suspension frame cabinet

### 2 / 3 drawers

- Completely bonded and doweled corpus made of melamin resin coated chipboards according to EN 14332
- All-around, pre-assembled pedestal with metal levelling feet to compensate surface irregularities
- Slotted, bonded back panel, 13 mm thick, as decorative rear
- Edges 2mm ABS, rounded
- Suspension frame from powder-coated sheet-steel, black, on telescopic slides, load rating 650 N
- With soft-close automatic
- Trims with segment bow metal handle 160 mm
- Top trim with cylinder lock with exchangeable cylinder
- Reciprocal pull-out locking mechanism tilt protection due to integrated counterweight

- **Colour**
  - **Final digit of order number .1:**
    - Fully light grey
  - **Final digit of order number .5:**
    - Body RAL 7021 black grey
    - Beech décor front
    - Segment bow handle, matt nickel plated
- **How supplied**
  - Assembled



800 x 1352 mm



800 x 772 mm

W	H	No. of drawers	Order no. (D 430)	Order no. (D 650)	UP
800	772	2	00.321.498.x	00.321.698.x	1 unit
800	1352	3	00.321.499.x	00.321.699.x	1 unit

## Safe-deposit cabinet

### with 8 compartments

- Completely bonded and doweled corpus made of melamin resin coated chipboards according to EN 14332
- All-around, pre-assembled pedestal with metal levelling feet to compensate surface irregularities
- Slotted, bonded back panel, 13 mm thick, as decorative rear
- 8 doors (4 left hinged, 4 right hinged)
- Doors with metal strap hinge with softclose-automatic, opening angle 110°
- Flush lock with changeable locking cylinder
- Edges 2 mm ABS, rounded
- Middle support wall panel and fixed installed shelves (Chipboard shelf volume-conductive in ESD version)

- **Colour**
  - **Final digit of order number .1:**
    - Fully light grey
  - **Final digit of order number .5:**
    - Body RAL 7021 black grey
    - Beech décor front
- **Supply schedule**
  - 1 Safe-deposit cabinet with individually locking doors.
- **How supplied**
  - Assembled



W	H	D	Order-no.	UP
1200	2064	430	00.321.500.x	1 unit

**Dimensions in mm:** W= Width  
 H = Height  
 D = Depth  
 OU = Office unit (50 mm)  
 FH = Folder height, min. 325 mm / 12,8"  
 Replace „x“ with the number of your color choice

LH = Left hinged  
 RH = Right hinged  
 Dw = Drawers  
 DU = Drawer unit  
 1 DU = 32 mm = 1¼"

# KNÜRR® SIT-STAND WORKSTATION

The base for a healthy office environment



**3 part telescopic lifting system**

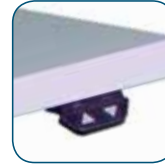

**Push-button switch for electronic desk lift**



## Accessories:



**Pedestals**



**Vertical Cable Guide**



**Horizontal Cable Duct**

Description	Order no.	UP
Desk, light grey	<b>04.322.225.A</b>	1 unit
Desk, nelson oak	<b>04.322.225.B</b>	1 unit
Vertical cable management	<b>04.322.231.9</b>	1 unit
Horizontal cable management	<b>04.322.235.9</b>	1 unit
Pedestal 1/3x3 OU, D600	<b>00.321.550.1</b>	1 unit
Pedestal 1/3/6 OU, D600	<b>00.321.551.1</b>	1 unit

## Sit-Stand vs. Fixed Height Workstations

**At least 80 per cent of work on computer screens is still done sitting down. Permanent sitting, unfavourable and restricted sitting posture, one-sided movements and so-called forced postures place considerable strain on the support and movement apparatus in the neck, shoulder and back area.**

Numerous occupational health studies prove this: In the office, every opportunity for more movement at work should be used, because two thirds of all users of sit-stand desks have demonstrably fewer

complaints in the back and neck area. Occupational physicians report about 40 per cent less absenteeism due to incapacity to work. Alternating between sitting and standing while working promotes general well-being, activates the heart and circulation, and prevents muscle inactivity. But that's not all: sitting/standing workplaces have been proven to contribute to better motivation and job satisfaction among employees - their performance increases by up to 20 per cent.

- Relief of the spine
- Activation of the cardiovascular system
- For every office workplace
- Promotes motivation and performance
- Reduction of days lost due to illness
- For all body sizes
- Electromotive height adjustment



- Three-part telescopic column
- Ambient temperature at installation site: +10° to +40 (only suitable for dry rooms)
- Power supply: 230V / 50Hz
- Power consumption: max. 350W (standby: 0.1W)
- Duty cycle: 10% ~ 6 min./H or 2 min. continuous operation at full load
- Lifting speed: max. 38mm/s (without load)
- Adjustment range: 630mm to 1270mm (640mm)
- Noise level: < 55dB
- Stable base frame with variable-width steel traverse
- Tabletop 30 mm, HPL - Coated with 3 mm ABS edging
- Dimensions: W x D 1600 x 800 mm
- Surface load: 80 kg
- Packaging units for easy self-assembly

# CONTRACT FURNITURE

