

DISPLAY MOUNTS FOR CONSOLES

189 to 194



Monitor Mounts - Functional Rails

Flat screen monitors are the main interface in today's control rooms between operator and system. According to ergonomic principles, monitors should always be easily adjustable towards the user and allow for quick change in order to reduce maintenance time to a minimum.

Dacobas Advanced Control Room Consoles can be equipped with the following monitor mounts while keeping all flexibility:

• Functional Rail on Dacobas Profile Extensions

- Large range of accessories like monitor arms, lighting, and much more make the Functional Rail a versatile platform. Mounts between two vertical profiles and a perforated rear panel.

• Functional Rail Add on Monitor Level

- Besides the various options of the standard Functional Rail, this version also offers an electric height adjustment in option. This allows a better view on videowalls behind the console.

- For additional information see also our catalogue "Ergonomic Flat Screen Supports".

• Surface

- RAL 9006 White aluminum



DAA20044



DAA20043



DAA20045

| W | H | Type | Model | Order-no. | UP |
|------------------------|---|------|--------------------------------------------|--------------|--------|
| 570 | | Duo | Knürr Dacobas® | 01.316.280.9 | 1 unit |
| 630 | | Duo | Knürr Dacobas® | 01.315.170.9 | 1 unit |
| 830 | | Duo | Knürr Dacobas® | 01.315.171.9 | 1 unit |
| 1030 | | Duo | Knürr Dacobas® | 01.315.172.9 | 1 unit |
| 1140 | | Duo | Knürr Dacobas® | 01.316.282.9 | 1 unit |
| 1200 | | Duo | Knürr Dacobas® | 01.316.283.9 | 1 unit |
| 1230 | | Duo | Knürr Dacobas® | 01.315.173.9 | 1 unit |
| 1430 | | Duo | Knürr Dacobas® | 01.315.174.9 | 1 unit |
| 1600 | | Duo | Knürr Dacobas® | 01.316.284.9 | 1 unit |
| 1630 | | Duo | Knürr Dacobas® | 01.315.175.9 | 1 unit |
| 1710 | | Duo | Knürr Dacobas® | 01.316.285.9 | 1 unit |
| 1830 | | Duo | Knürr Dacobas® | 01.315.176.9 | 1 unit |
| 2030 | | Duo | Knürr Dacobas® | 01.315.177.9 | 1 unit |
| 45° - corner | | Duo | Knürr Dacobas® | 01.315.180.9 | 1 unit |
| 90° - wall corner | | Duo | Knürr Dacobas® | 01.315.181.9 | 1 unit |
| 90° - trapezoid corner | | Duo | Knürr Dacobas® | 01.315.182.9 | 1 unit |
| 22.5° | | Duo | Knürr Cicon | 01.315.185.9 | 1 unit |
| 800 | | Duo | Knürr Elicon® | 04.208.210.9 | 1 unit |
| 1000 | | Duo | Knürr Elicon® | 04.208.211.9 | 1 unit |
| 1200 | | Duo | Knürr Elicon® | 04.208.212.9 | 1 unit |
| 1400 | | Duo | Knürr Elicon® | 04.208.213.9 | 1 unit |
| 1600 | | Duo | Knürr Elicon® | 04.208.214.9 | 1 unit |
| 1800 | | Duo | Knürr Elicon® | 04.208.215.9 | 1 unit |
| 2000 | | Duo | Knürr Elicon® | 04.208.216.9 | 1 unit |
| 1600 | | | Monitor Level, circular | 93.200.317.3 | 1 unit |
| 1600 | | | Monitor Level, circular, height adjustable | 93.200.314.3 | 1 unit |

Dimensions in mm: W = Width
 H = Height
 D = Depth
 h = Installation height
 d = Usable depth
 L = Length

HEA = electronically height adjustable
 HA = height-adjustable

UP = Unit of packaging
 kg = Weight

Conversion: 1 inch = 25,4 mm
 Replace „x“ with the number of your color choice

Monitor Arms for functional rail

- Monitor arms for mounting flat screens with the 75 and 100 mm VESA mounting
 - With cable management
 - For mounting on the Knürr double function rail
 - Integrated quick-fastening system
- **Supply schedule**
 - 1 flat screen support
 - With integrated height adjustment plate
 - Mounting material
 - **How supplied**
 - Flat-packed kit
 - **Type D-G**
 - For mounting on Knürr functional rail. Swivel arms for individual depth adjustment
 - Quick mounting rail adapters
 - Free placement on horizontal double functional rails
- **Finish / Material Type D-G**
 - Swivel arm: die-cast aluminium
 - Adapter plates: sheet steel
 - Gas spring arm covers: plastic
 - Metal parts: powder-coated, RAL 9006, White aluminum, smooth
 - Gas spring arm housing – type B/C:
 - Plastic, light grey
 - **Type H**
 - With extension arm
 - Integrated gas spring
 - With quick connector function (01.316.257.9)
 - **Finish / Material Type H**
 - Gas spring arm housing: Die-cast aluminum, silver
 - Extension arm: Aluminum, silver

| Model | Height adjustment plate | Load-bearing capacity | Order no. | UP |
|---------------------------------------|-------------------------|-----------------------|--------------|--------|
| Type D, short (130 mm) | • | 15 Kg | 01.316.210.7 | 1 unit |
| Type E, medium (130+150 mm) | • | 15 Kg | 01.316.211.7 | 1 unit |
| Type F, long (130+200 mm) | • | 15 Kg | 01.316.212.7 | 1 unit |
| Type G, double joint (130+200+150 mm) | • | 15 Kg | 01.316.213.7 | 1 unit |
| Mounting Adaptor IM-Profile | | | 01.316.214.9 | 1 unit |

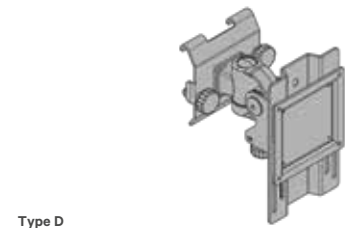

Type D

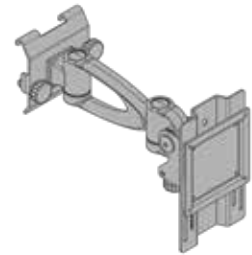

Type E

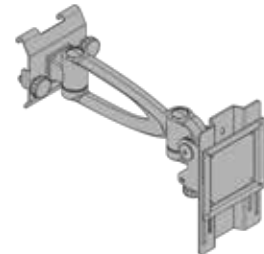

Type F

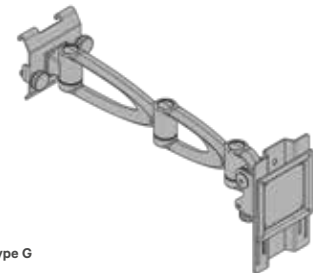

Type G



IM Profile Adaptor

DAA20059

Monitor Mounts - Tube Mount System

- Flat screen mount for flat screens with VESA bracket 75 and 100 mm
- With integrated cable routing
- **Supply schedule**
 - 1x flat screen mount
 - Type E, F, G with accompanying height compensation plate
 - Mounting material
- **How supplied**
 - Flat-packed kit
- **Type D-G**
 - For mounting on Knürr top screen mounting columns for custom depth and height adjustment
 - Freely selectable mounting position on tabletop thanks to practical clamping system
- **Material/Surface Type D-G**
 - Swivel arms: die-cast aluminum, powder-coated, RAL 9006 White aluminium
 - Adapter: steel panel, powder-coated, smooth, RAL 9006 White aluminium
 - Covers on screen arms: plastic, clear

| Model | Height compensation plate | Capacity | Order-no. | UP |
|-----------------------------------------------------|---------------------------|----------|--------------|--------|
| Type D, for top screen mounting column (short) | | 15 kg | 01.316.250.7 | 1 unit |
| Type E, for top screen mounting column (150 mm) | • | 15 kg | 01.316.251.7 | 1 unit |
| Type F, for top screen mounting column (200 mm) | • | 15 kg | 01.316.252.7 | 1 unit |
| Type G, for top screen mounting column (150x200 mm) | • | 15 kg | 01.316.253.7 | 1 unit |
| | | | | |
| Tube mount for IM functional rail H400 | | | 01.316.254.9 | 1 unit |
| Tube mount for dual function rail H400 | | | 01.316.255.9 | 1 unit |
| | | | | |
| Tube mount with clamp system (H400) | | | 01.316.231.9 | 1 unit |
| Tube mount with clamp system (H700) | | | 01.316.232.9 | 1 unit |
| | | | | |
| Tube mount with screw fitting (H400) | | | 01.316.233.9 | 1 unit |
| Tube mount with screw fitting (H700) | | | 01.316.234.9 | 1 unit |



Type D

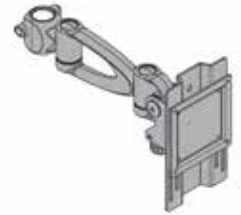

Type E

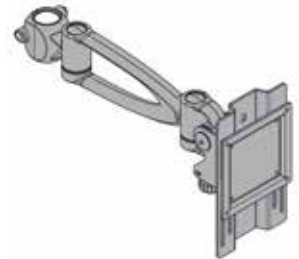

Type F

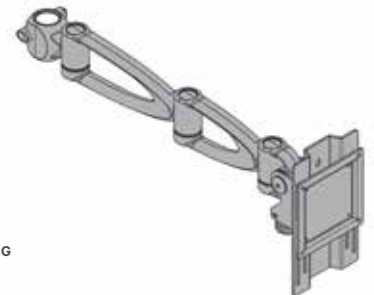

Type G

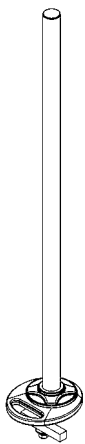

ACC20029

Pipe bracket for screw fitting

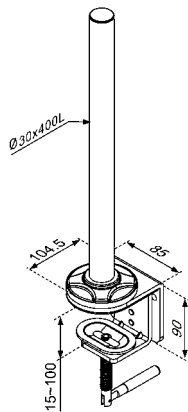

Pipe bracket with clamp mount

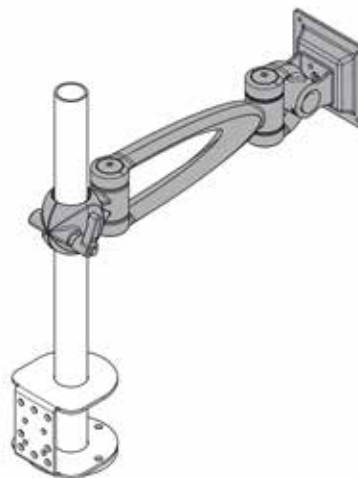

Pipe bracket for functional rail

VESA Adapter Plates

- For adapting VESA 100/200 and VESA 200/200 threaded connections to VESA 75 and VESA 100
- Single adapter for monitors up to 12 kg
- Double adapter for monitors up to 24 kg on 2 Vesa 75/100 holders
- **Supply schedule**
 - 1 adapter plate
 - Mounting material
- **How supplied**
 - Flat-packed kit
- **Material**
 - Sheet steel
- **Finish**
 - Powder-coated, RAL 9006, white aluminum



DAC20175



DAC20176

| W | H | Model | Order-no. | UP |
|-----|-----|--------|---------------------|--------|
| 220 | 220 | Single | 01.316.244.9 | 1 unit |
| 501 | 250 | Double | 01.316.245.9 | 1 unit |

VESA Fast Change Plate

- Quick, tool-less monitor swap-out via spring balancer
- For adapting VESA 75/100 threaded connections
- With height adjustment holes
- Low installation depth – only 15 mm
- **Supply schedule**
 - 1 adapter plate
 - Mounting material
- **How supplied**
 - Flat-packed kit
- **Dimensions**
 - Width 130 mm
 - Height 170 mm
 - Depth 15 mm
- **Material**
 - Sheet steel
- **Finish**
 - Powder-coated, RAL 9006, white aluminum



ERG00040

| W | H | D | Order-no. | UP |
|-----|-----|----|---------------------|--------|
| 130 | 170 | 15 | 01.316.239.9 | 1 unit |

Touchscreen Mount inclinable

- Display holder with integrated and stepless tilt adjustment.
- Inclination angle freely adjustable from 25° - 70° for individual and ergonomic operation of the touch display.
- Simple and flexible positioning on the tabletop.
- Suitable for displays with VESA 75/100 mount.
- **Material**
 - Sheet steel, powder-coated
- **Surface**
 - RAL 7021, dark grey
- **Supply schedule**
 - 1 Touchscreen mount
 - Mounting material
- **How supplied**
 - As Set



| Type | Order-no. | UP |
|------------------------------|---------------------|--------|
| Touchscreen Mount inclinable | 04.501.015.9 | 1 unit |

Dimensions in mm: W = Width
 H = Height
 D = Depth
 h = Installation height
 d = Usable depth
 L = Length

HEA = electronically height adjustable
 HA = height-adjustable

UP = Unit of packaging
 kg = Weight

Conversion: 1 inch = 25,4 mm
 Replace „x“ with the number of your color choice

Cable Duct Functional Rail 25 mm

- For structured cabling at the monitor level
 - Finger design allows to let out cables exactly where needed
 - Simple, retrofittable installation grace to plastic quick locks
 - 400 mm elements, free placement
- **Material / Finish**
 - Sheetsteel, powder-coated texture, RAL9006
 - Plastic black
 - **Supply schedule**
 - 1 Cable duct segment
 - Mounting material
 - **How supplied**
 - flatpacked
 - **Please note**
 - Please also ask for matching brush strips for dust cover!

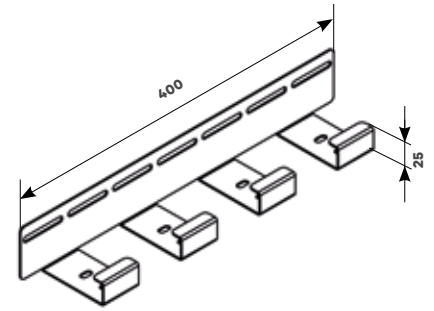

DAA20057

| W | Type | Model | Order-no. | UP |
|-----|-------|-----------------|--------------|--------|
| 400 | 25 mm | Functional rail | 04.300.414.9 | 1 unit |

Accessories for Multi-Functional Rails

- Organizational elements, compatible design for Knürr multi-functional rails
 - 430 mm console – also perfect as telephone stand
- **Supply schedule**
 - 1 Organizational element
 - **How supplied**
 - In batches
 - **Material**
 - Sheet steel
 - **Finish**
 - Powder-coated, RAL9006 White aluminum



Tray console 430 mm

DAC20091

| Model | Order no. | UP |
|----------------------|--------------|--------|
| Tray shelf DIN A4 | 04.300.400.9 | 1 unit |
| Box with note pad | 04.303.103.9 | 1 unit |
| Tray shelf DIN A3 | 04.300.401.9 | 1 unit |
| Tray console 430 mm | 04.303.106.9 | 1 unit |
| Magazine file DIN A4 | 04.303.110.9 | 1 unit |



Box with note pad

DAC20089

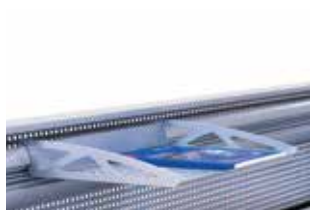

Tray shelf DIN A3

DAC00600

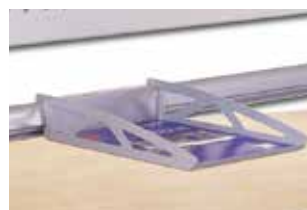

Tray shelf DIN A4

DAC20082

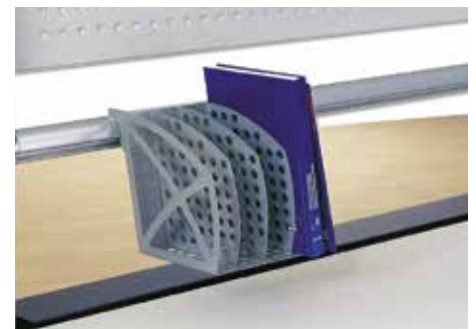

Magazine file DIN A4

DAC20090

Cable Entry

- Cable entry for additional or retro cable input and output installation
 - Type 1: 183 x 98 mm
 - Type 2: diameter 80 mm
- **Supply schedule**
 - 1 Cable entry, 3-piece

| Finish | Model | Order-no. | UP |
|-------------------------|--------|--------------|--------|
| RAL 7035 light-grey | Type 1 | 01.350.156.1 | 1 unit |
| RAL 7035 light-grey | Type 2 | 01.350.145.1 | 1 unit |
| RAL 9011 graphite black | Type 1 | 01.350.156.5 | 1 unit |
| RAL 9011 graphite black | Type 2 | 01.350.145.5 | 1 unit |



DAC00447